

WRD289 Connector

Drawing Dimensions in MM

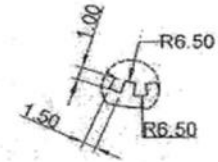

Scale 2:1
Detail - A

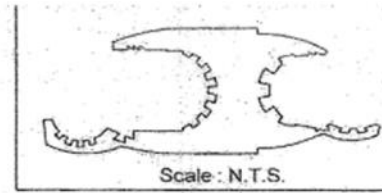
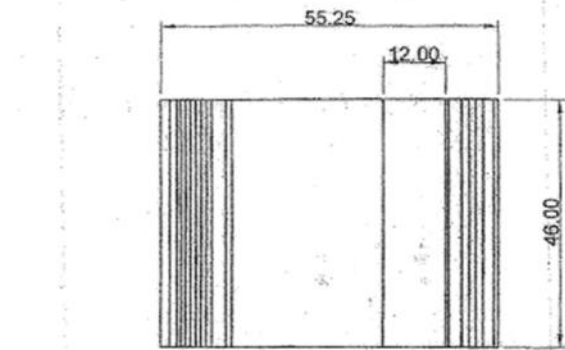
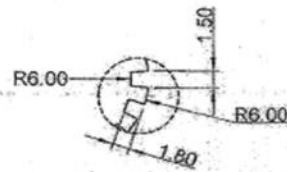
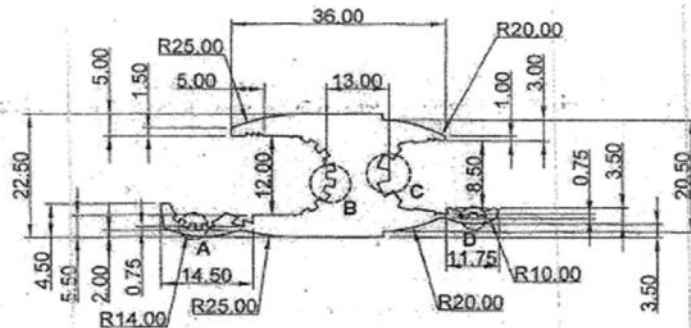

Scale 2:1
Detail - B

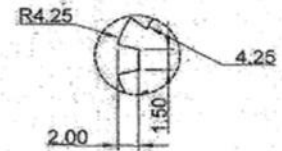

Scale 2:1
Detail - C

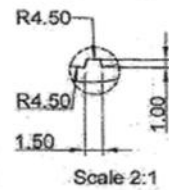
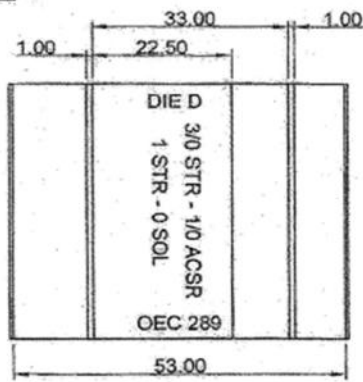

Scale 2:1

Material-Aluminum

Drawn - SD
Approval - KM



Title - WRD289 Connector

Part Number	Standard Conductors						Compact Conductors				L	W	H
	A Groove			B Groove			A Groove		B Groove				
	ASCR	STR	SOL	ASCR	STR	SOL	ASCR	STR	ASCR	STR			
WRD289	-	-	-	-	-	1/0	-	-	-	-	1.811	2.175	0.885
	-	-	-	-	1	1	-	-	1	1			
	-	-	4/0	2	2	2	3/0	3/0	2	2			
	-	3/0	3/0	3	3	3	2/0	-	3	3			
	2/0	2/0	-	4	4	4	-	-	4	4			
	1/0	-	-	6	6	6	-	-	6	6			